

mogogo



2024 CATALOG

# Cantine

DISPLAY CART

DISTRIBUTED BY:





**STANDART CART** MGCCNT04DSXX



## INDEX

- 4 About Mogogo
- 8 About The Cantine Collection
- 9 Materials
- 10 How it works
- 12 Details
- 16 All configurations
- 22 System Breakdown



A MODULAR F&B  
FURNITURE BRAND



OUTDOORS



# BORN FROM A PASSION FOR **STYLE & GASTRONOMY**



Mogogo is led by designers and chefs that are aiming to introduce innovative, luxurious, and highly functional equipment to foodservice professionals.



MODULAR



MOBILE



SUSTAINABLE



ADD ONS



CART WITH SHELF AND SIGN MGCCNT03DSXX









STANDARD CART MGSCNT04DSXX

## ABOUT THE CANTINE COLLECTION

Mogogo's cover version of the archetype iconic market cart. Those carts have existed for centuries for goods transportation and for merchandise displaying at markets around the world. Mogogo revives this concept, by updating the design and materials while respecting the past.





## MATERIALS

Bent bamboo beams are the core of the Cantine Cart, giving the construction strength in a streamlined style. The lightweight bamboo structure is durable, and with additional decorative metal elements it creates a fine tension between a traditional look and advanced design. The cart arrives in dark brown stained bamboo finish, with optional Copper metalwork Steel or black plated wheels.

## HOW IT WORKS

All components of the basic cart fit in the main crate, making it affordable to ship and fun to receive. Additionally, adds-ons enhance the cart into several concepts which can literally fit anywhere. The airless 26" wheels will perform on most terrain, making this cart a perfect companion for transit.

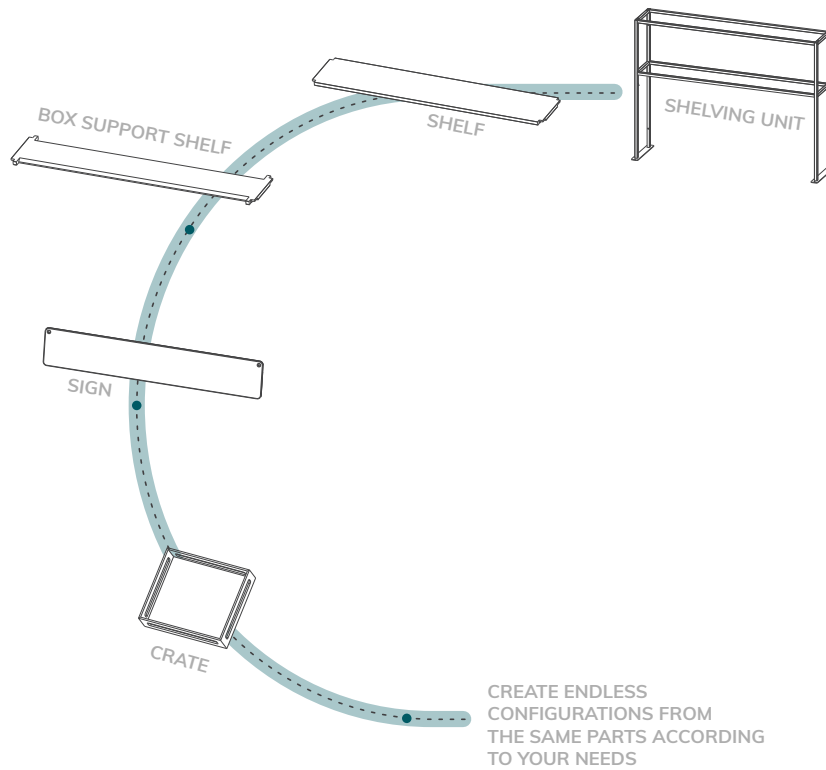
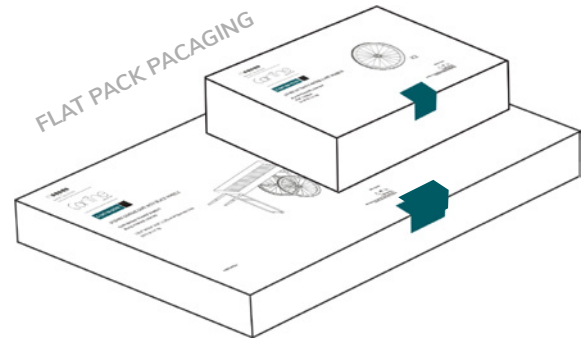



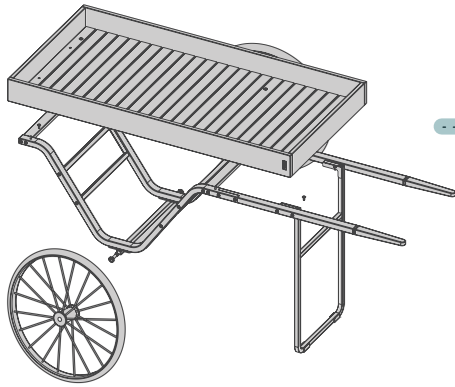

FAST AND EASY ASSEMBLY

CUSTOMIZE WITH ADD-ONS

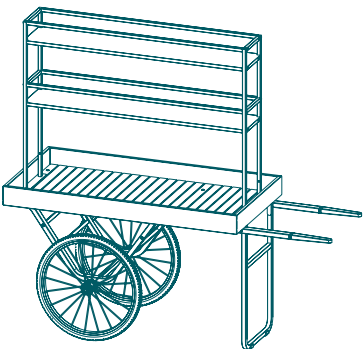
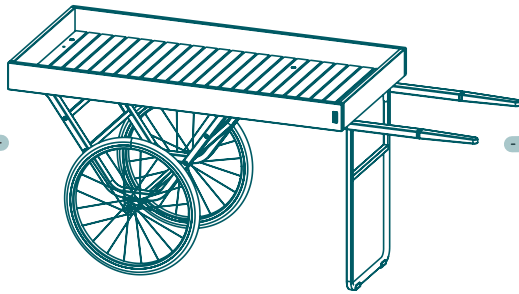

CART WITH SHELVES  
MGCCNT01XXXX

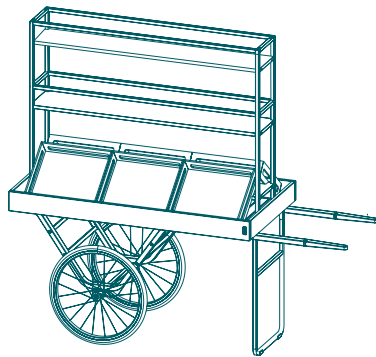

CART WITH SHELF & CRATES  
MGCCNT05XXXX

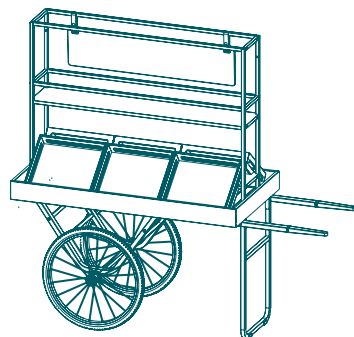

CART WITH SHELF & CRATES & SIGN  
MGCCNT05XXXX

# DETAILS





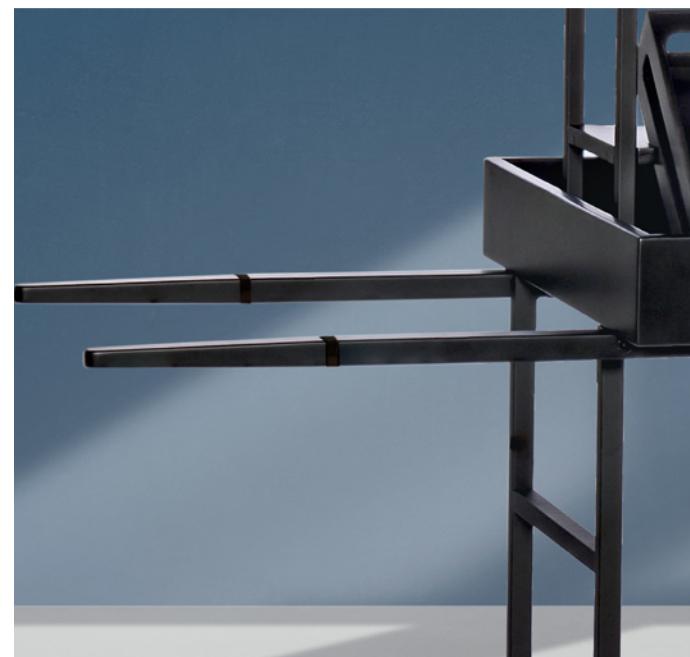





CART WITH SHELVES AND CRATES MGCCNT02DSXX





## STANDARD CART

The Standard Cart offers a unique and beautiful platform for F&B presentations.

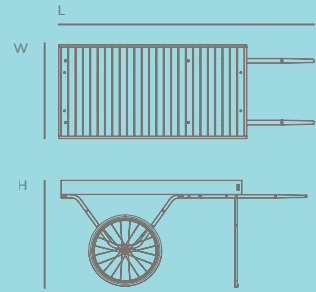

L80½" W30" H36"

L204.5cm W76cm H92cm



Choose between two wheel finishes:

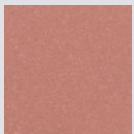

COPPER | MGCCNT04DPXX

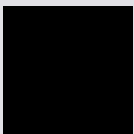

BLACK | MGCCNT04DSXX







**STANDART CART** MGSCNT04DSXX



## CART WITH SHELVES

This cart with shelving makes perfect sense and provides 2 two shelves with borders that can hold bavrges while on the cart surface there is space for products and decoration.

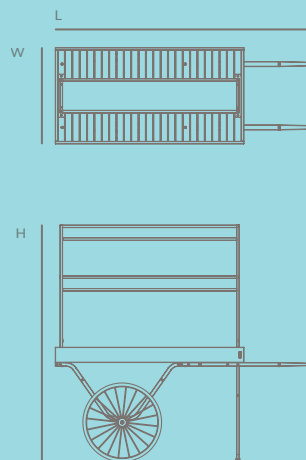

L80½" W30" H71"

L204.5cm W76cm H188cm

Choose between two wheel finishes:

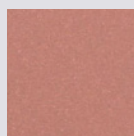

COPPER | MGCCNT01DPXX

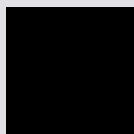

BLACK | MGCCNT01DSXX





**CART WITH SHELVES** MGCNT01DSXX



## CART WITH SHELVES AND CRATES

A perfect configuration for pastries and such. The crates are the ultimate display vessel for and is certain to be an eye-catcher for all occasions.

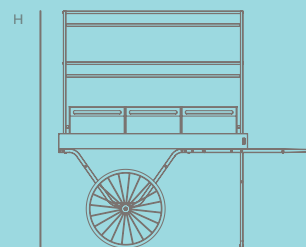
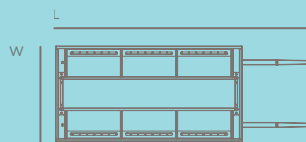

L80½" W30" H71"

L204.5cm W76cm H188cm

Choose between two wheel finishes:

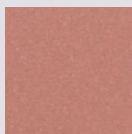

COPPER | MGCCNT02DPXX

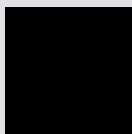

BLACK | MGCCNT02DSXX

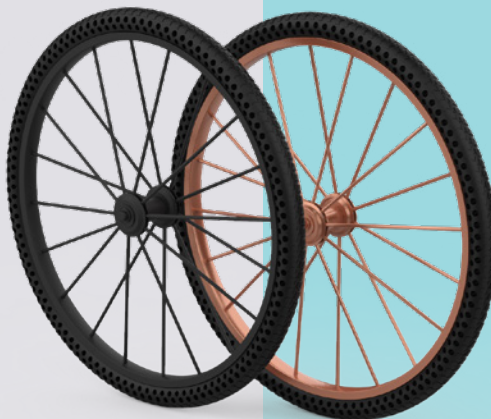



CART WITH SHELVES AND CRATES MGCCNT02DSXX









## SYSTEM BREAKDOWN

The Cantine consists of the base cart packed within its own crate. Inside, the large wheels, the handle, and all fittings are located seamlessly. On top of the cart, the shelving structure can be easily added creating a versatile display cart for hospitality. The Cantine can be shipped flat like everything Mogogo does.

## BUILD YOUR OWN UNITS

---

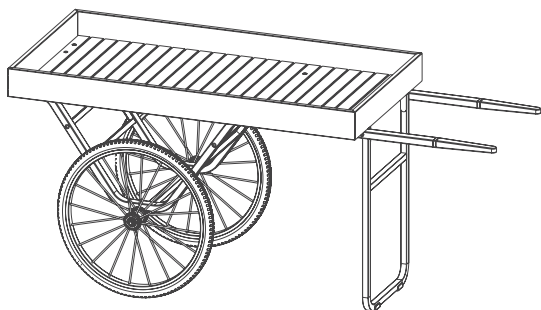

**STANDART CART**  
 L80½" W30" H36"  
 L204.5cm W76cm H92cm



Dark brown stained  
 bamboo Sandblasted  
 Black plating  
 stainless steel

MGCCNT04DSXX

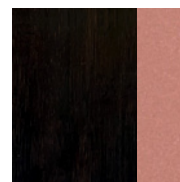

Dark brown stained  
 bamboo Sandblasted  
 Copper plating

MGCCNT04DPXX

## ADD-ONS

---

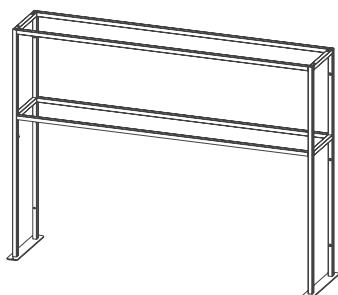

**SHELVING UNIT**  
 L55.5" W30" H43.1"  
 L141cm W76cm H1097cm

MGSCNTMT0201

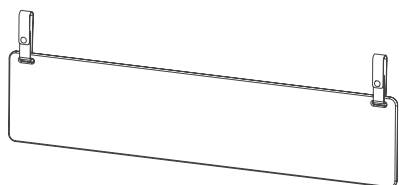

**CANTINE SIGN POST**  
 L43½" W9½" H0.4"  
 L110cm W24.5cm H1cm  
 Fits shelving unit  
 Comes with 2 leather straps

MGSCNTSM0501

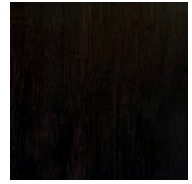

Dark brown stained  
bamboo

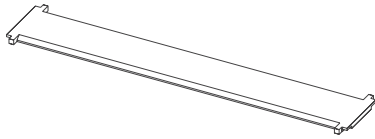

**CRATE SUPPORT SHELF**  
L55½" W10½" H0.8"  
L141cm W26.5cm H2cm

MGSCNTDB0401

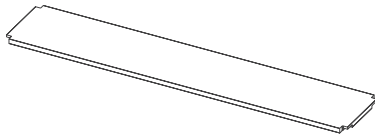

**SHELF**  
L55½" W10½" H0.8"  
L141cm W26.5cm H2cm

MGSCNTDB0501

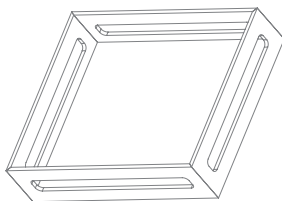

**CRATE**  
L17½" W14.½" H4"  
L44cm W37.5cm H10cm  
Fits Box support shelf

MGSCNTDB0601





CART WITH SHELVES MGCCNT01DSXX



**steelite**  
INTERNATIONAL

[www.steelite.com](http://www.steelite.com)

Steelite International America  
Headquarters & Corporate Office  
255 West Federal Street  
Youngstown, Ohio 44503  
toll free: 800-367-3493  
telephone: 724-856-4900  
fax: 724-856-7925  
email: [usa@steelite.com](mailto:usa@steelite.com)

Steelite International America  
Warehouse & Distribution Center  
154 Keystone Drive  
New Castle, Pennsylvania 16105  
toll free: 800-367-3493  
telephone: 724-856-4900  
fax: 724-856-7925  
email: [usa@steelite.com](mailto:usa@steelite.com)

Steelite International Canada  
26 Riviera Drive, Unit 2  
Markham, Ontario L3R 5M1  
toll free: 800-465-4284  
telephone: 905-752-1074  
fax: 905-752-1120  
email: [canada@steelite.com](mailto:canada@steelite.com)

Showrooms available by appointment  
Atlanta • Chicago • Hong Kong • London, UK  
Los Angeles • Madrid • Miami • New York  
Stoke-on-Trent, UK • Toronto, ON • Washington, D.C.  
Youngstown, OH

Mogogo Catalogs



US Patent no US010415618B2  
US Patent no US009210998B2  
More configurations can be found on our website  
Dimensions are approximated due to conversions  
The entire content is subject to misprints and errors  
Item No. LCMGCANTINE124





[www.mogogo-buffet.com](http://www.mogogo-buffet.com)  
[info@mogogo-buffet.com](mailto:info@mogogo-buffet.com)

---

DISTRIBUTED BY: 

### CHECK OUT OUR OTHER COLLECTIONS



Modular  
SYSTEM



Roll'n  
SERVICE CARTS



Canvas  
SHELVING SYSTEM



Clix  
TABLES



Grabit  
SIDE TABLES



V-Shield  
SYSTEM



PoLo  
TABLES